



# 07 Sample ring kits

## OPERATING INSTRUCTIONS



### Contents

On these operating instructions .....	2
1. Introduction.....	2
2. Description .....	2
2.1 Soil sample rings .....	2
2.2 Sample ring kit with open ring holder (07.53.SA).....	3
2.3 Sample ring kit with closed ring holder (07.53.SC, 07.53.SE, 07.60.SC and 07.84.SC) .....	3
2.4 Augers .....	4
2.4.1 Edelman auger .....	4
2.4.2 Riverside auger .....	4
3. Technical specifications .....	5
4. Safety .....	5
5. The use .....	6
5.1 Sample ring kit with open ring holder (07.53.SA).....	6
5.2 Sample ring kit with closed ring holder (07.53.SC, 07.53.SE, 07.60.SC and 07.84.SC) .....	7
5.3 Augers .....	9
5.4 Hammering head for sample rings .....	10
6. Applications.....	10
7. Problems and solutions .....	11
8. Maintenance.....	11
Appendix: Rust on augers and gouges .....	12

**All it takes for environmental research**

P.O Box 4, 6987 ZG Giesbeek,  
The Netherlands

**T** +31 313 88 02 00  
**F** +31 313 88 02 99

**E** info@eijkelkamp.com  
**I** www.eijkelkamp.com



a Royal Eijkelkamp Company

## On these operating instructions



When the symbol shown on the left is placed before a piece of text, this means that an important instruction follows.



When the symbol shown on the left is placed before a piece of text, this means that an important warning follows pointing out a risk of injury to the user or damage to the device. The user is always responsible for its own personal protection.

*Text*

**Text in italics means that the actual text is shown on the display screen.**

## 1. Introduction

Soil research is a very important aspect of the planning and execution of agricultural, cultural and civil engineering projects.

The basis for soil research is to make a study of:

- The soil profile.
- The physical properties of the soil.

The physical properties of soils are largely determined in the laboratory. Such laboratory studies usually require undisturbed soil samples, preferably with uniform dimensions. To collect undisturbed soil samples, use is made of soil sample rings with a known volume and diameter.

Various sample sets have been developed to allow samples of undisturbed soil to be collected in soil sample rings.

## 2. Description

These instructions for use describe 5 different types of soil sample ring sets that differ from each other because of the ring holder that is used, the diameter of the ring, the selected type of connection and the sampling method.

### 2.1 Soil sample rings

Soil sample rings are stainless steel rings made of seamless tube, which is smooth on both the inside and outside. The bottom of the ring has a cutting edge with an angle of 15°. The sample rings are manufactured to tight tolerances with respect to dimensions, volume and weight. This makes them highly suitable for collecting samples for laboratory studies. During sampling, a soil sample ring is forced into the soil, causing it to fill entirely with undisturbed soil.



## 2.2 Sample ring kit with open ring holder (07.53.SA)

The sample sets with the postfix SA are used to take samples of soft soils above the groundwater level to a depth of up to 2 m. The soil sample rings can be easily and rapidly fitted and removed.

The set 07.53.SA is intended for sample rings of  $\varnothing$  53 mm. The samples can be taken from the surface, from the bottom of auger holes or from soil profile pits.

The open ring holder (see the figure to the right) is fitted with a cylinder (2) that is split in two. One part is welded to the auger rod (6). The other part is attached via a lever (4) to a hinge (3). A sample ring (1) is inserted approximately 1 cm into the two cylinder halves. The sample ring is clamped into the ring holder when the sleeve (5) is slid tightly under the lever (4).

The bayonet connection (7) is used to connect the top section, including the handle, or if required the extension rods (8). After assembly, with the sample ring in the open ring holder and the top section connected, the sample can be taken by forcing the entire tool into the soil. If required, the Edelman (21) and Riverside augers (22) can be used in advance to make auger holes (see photo page 4).

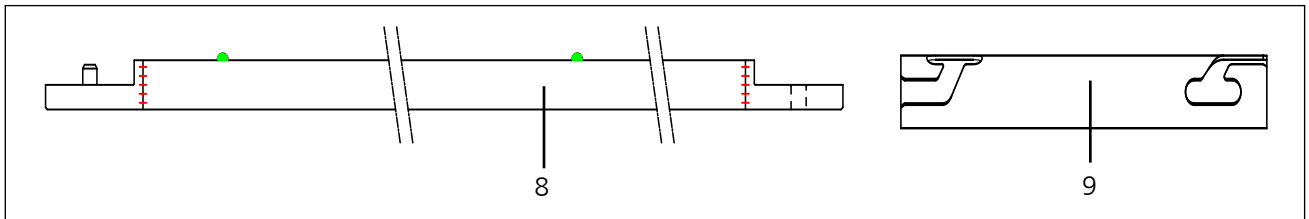
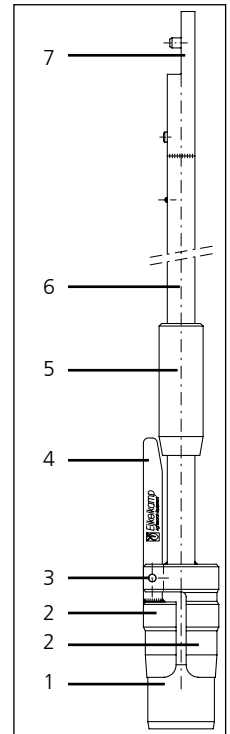

## 2.3 Sample ring kit with closed ring holder (07.53.SC, 07.53.SE, 07.60.SC and 07.84.SC)

The sample sets with the postfix SC and SE can be used to take samples in virtually all types of soil to a depth of 2 m. The samples can be taken from the surface, from the bottom of auger holes or from soil profile pits, both above and below the groundwater level.

After a sample ring (1) has been fitted in the cutting shoe (10), the ring holder is connected to the ring holder top part (14). The closed ring holder is held in place by the retaining ring (11) and the locking pins (12).

During sampling, the vent valve (13) allows overpressure to be released while underpressure keeps the sample material in the sample ring when the sampling equipment is removed from the ground.

The closed ring holder has a tapered-thread connection (15) that can be used to attach the top part including the hammering head (19, see photo on page 4) and the extension rods (18). After assembly, when the sample ring is fitted in the closed ring holder and the top part is connected, a sample can be taken. If required, the Edelman (21) and Riverside augers (22) can be used in advance to make auger holes

The hammering head (16) and guide cylinder (20) can be used to take samples from the surface or from soil profile pits. The sample ring is clamped in the hammering head by a retaining ring (17). The guide cylinder (20) can be held rigidly to the ground using its 3 pins, so that the sample can be taken in a straight line.

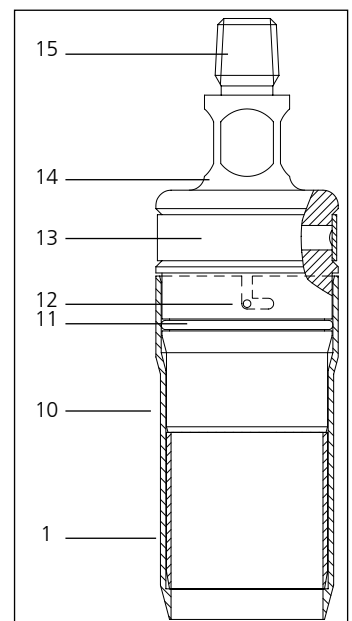

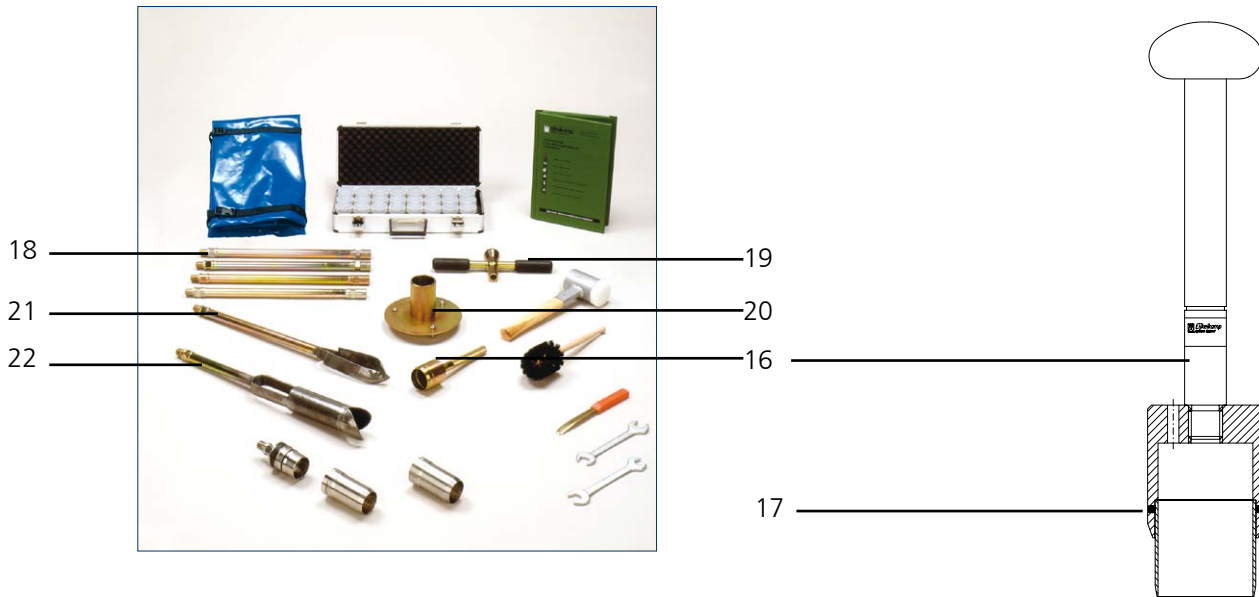

## 2.4 Augers

All soil sample sets contain an Edelman (21) and a Riverside auger bottom part (22). The open ring holder soil sample set, set 07.53.SA, use a bayonet connection to connect the bottom part to a top part or extension rod. The other sets have a tapered thread connection.

### 2.4.1 Edelman auger

The augering body of the Edelman auger is tapered and consists of two blades (38) that come together at the auger point (39), and that are connected at the top to the bottom part (36) via a bracket (37). The two blades are positioned next to each other in the auger point and form as it were two spoons. When augering, the auger point rotates in the soil and steadily moves the soil from the bottom of the auger hole into the auger body. The function of the auger blades is to take up and keep together the soil sample in the auger body, in such a way that it is also easy to remove. Using the combination type Edelman auger, less cohesive soils can be held together reasonably well, while cohesive soils can still be rather easily removed from the auger body.

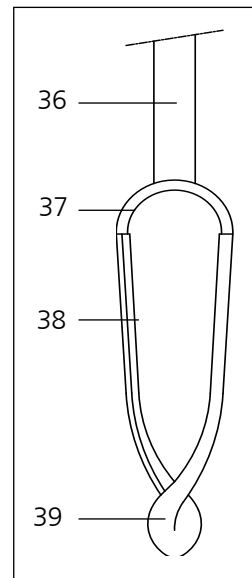

### 2.4.2 Riverside auger

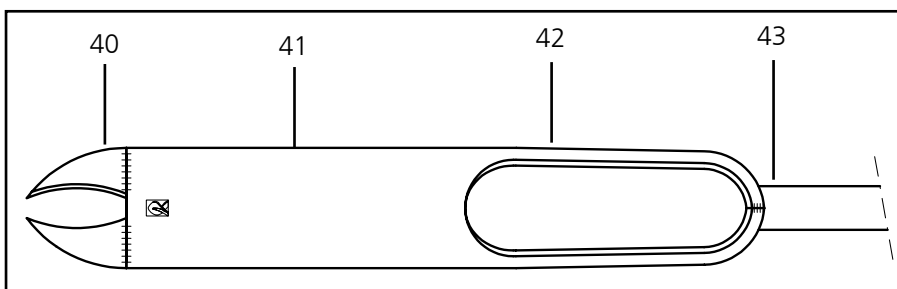

In addition to the Edelman auger, the Riverside auger can also be used for hard or dry soils. This auger also makes a rather smooth auger hole, which is a good starting point for taking a ring sample (see figure page 9). The auger body consists of an open tube (41) with below it two spoon-shaped side pieces (40). A bracket (42) attaches the open tube to the bottom part (43). The points of the side pieces that slant downwards scrape the soil loose, after which it is steadily pushed into the tube. The side pieces are somewhat wider than the tube, meaning that there is minimum friction between the auger and the soil. The auger is unloaded above the ground by turning it over and/or by giving it a tap.

### 3. Technical specifications

Versions of soil sample ring kits	Soil sample rings		volume	Details
	cross section	height		
07.53.SA	Ø 53 mm	51.0 mm	100 cc	open ring holder
07.53.SC	Ø 53 mm	51.0 mm	100 cc	closed ring holder
07.53.SE	Ø 53 mm	51.0 mm	100 cc	closed heavy duty ring holder
07.60.SC	Ø 60 mm	40.5 mm	100 cc	closed ring holder
07.84.SC	Ø 84 mm	50.0 mm	250 cc	closed ring holder

### 4. Safety



Before starting to use the auger, determine whether there are (electricity) cables or pipes in the ground (in the Netherlands the Klic can provide this information). Use the pricker to safely investigate the augering location. If there are any obstacles present, choose another location.



Watch for pieces of plastic in the soil samples. They can originate from an electricity cable. When augering, always hold the top section of the auger by the plastic handle. The handle provides substantial insulation, if despite the precautions taken an electricity cable is hit.



Hold the locking sleeve in the middle. This prevents the skin from being trapped under the locking sleeve when connecting and disconnecting the parts of the auger.



Do not hit the auger or use excessive force. Hitting can cause serious damage, including cracks in the steel or broken connections.



After augering, fill the hole with the material that was extracted or by using special bentonite plugs. This prevents people or animals being injured as a result of stepping into the hole. Moreover, impermeable soil layers are restored.



Be careful during storms. In an open field the chance of being struck by lightning is greater, especially while holding a metal object.



The sample rings have one sharp side. Prevent cuts to the fingers.



If impact force is required, always use the impact absorbing hammer. It is safer and prevents damage to the equipment. Never use a non-impact absorbing (metal) hammer. This can damage the auger and there is a chance of injury resulting from the recoil of the hammer.

## 5. The use

Make a proper plan as to where and at what depths the soil samples must be taken.



**Before starting to use the auger, determine whether there are (electricity) cables or pipes in the ground (in the Netherlands the Klic can provide this information). Use the pricker to safely investigate the augering location. If there are any obstacles present, choose another location.**



**Watch for pieces of plastic in the soil samples. They can originate from an electricity cable. When augering, always hold the top section of the auger by the plastic handle.**

### 5.1 Sample ring kit with open ring holder (07.53.SA)

1. Screw the plastic handle onto the top section.
2. Connect the auger parts together (see figure).
  - 2.1 Hold the locking sleeve in the middle and slide it onto the top part so that it remains suspended on the connecting pin (step 1). The locking sleeve is locked if it can no longer turn.
  - 2.2 Then hook the top and bottom part together (step 2).
  - 2.3 To lock the connection, the locking sleeve is now unscrewed from the top part, slid over the connection (step 3) and locked on the connecting pin on the bottom part (step 4). Check the lock. Note that there is always some play in the connection.



**Always hold the locking sleeve in the middle. This prevents the skin from being trapped under the locking sleeve when connecting and disconnecting the parts of the auger.**

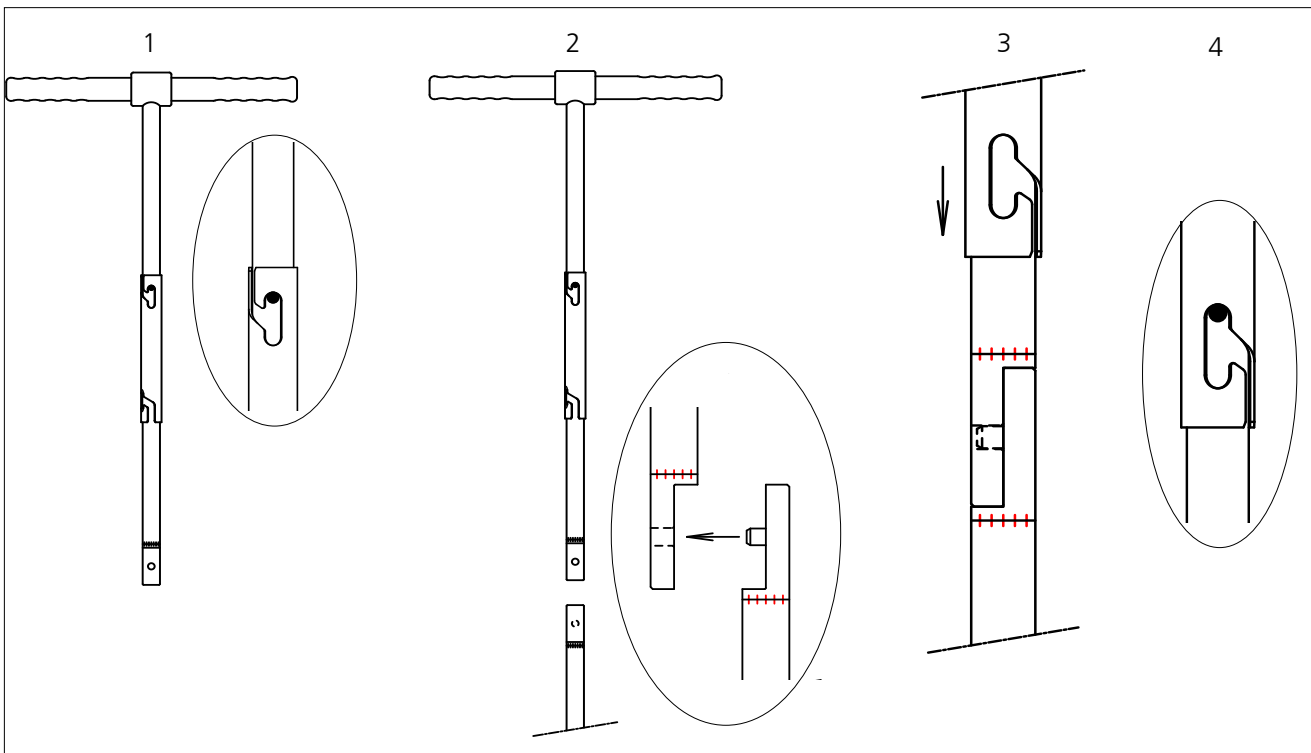

3. Use the Edelman and/or Riverside auger to bore to the desired depth (see subsection 5.3). The Riverside auger makes an auger hole with smooth sides.
4. Fit the open ring holder to the top part with the plastic handle.
5. Slide the sleeve (5) so that the ring holder can be opened.

6. Fit a sample ring in the ring holder. The sharp edge of the soil sample ring is outside of the open ring holder.
7. Slide the sleeve (5) tightly under the lever (4) so that the sample ring is securely clamped.
8. Allow the ring holder together with the fitted handle to drop to the bottom of the sample hole. Make a reference mark on the extension rod so that it is simple to determine the depth to which the ring holder should be pushed into the soil.
9. Push the ring holder in a straight line into the soil, so that the entire sample ring is filled. However, do not push too far, to avoid compressing the soil in the sample ring.
10. Turn the ring holder a quarter turn (90°) to separate the sample material in the sample ring from the soil.
11. Lift the ring holder while turning it slowly.
12. Slide the sleeve (5) away from the lever (3) so that the sample ring can be removed.
13. Remove the sample ring from the equipment and use a saw to remove the excess soil.

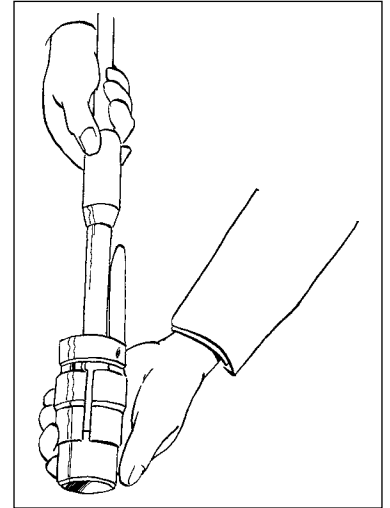

**Ensure that the sample does not become damaged when the excess material is removed as a result of it being smeared out or by removing too much material.**

14. Fit the protective covers over the sample rings, record the details and store the rings in the supplied case.
15. After taking each sample, thoroughly clean the sample ring holder with a wire brush, so that the sample rings can be fitted and removed easily. This also prevents the sample from being contaminated.
16. Before storing the equipment, thoroughly clean and dry the augers, the sample ring holder and the other parts.

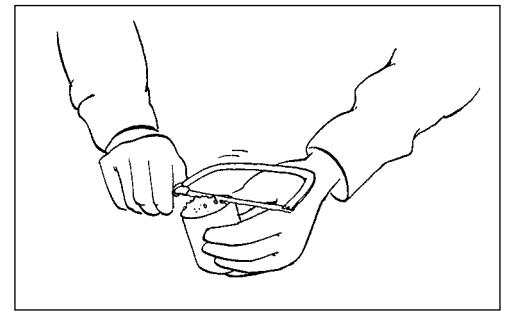

## 5.2 Sample ring kit with closed ring holder (07.53.SC, 07.53.SE, 07.60.SC and 07.84.SC)

For instructions on how to use the hammering head (16) with the guide cylinder (20) see subsection 5.4.

1. Screw the bottom part with the Edelman auger to the top part with hammering head, using both open-ended spanners.
2. Use the Edelman and/or Riverside auger to bore to the desired depth (see subsection 5.4). The Riverside auger makes an auger hole with smooth sides. (See figure page 8)
3. Rotate the cutting shoe (10) in the groove of the bayonet connection in such a way that it can be slid off in a straight line.
4. Fit the sample ring in the cutting shoe (10). The sharp edge of the sample ring must be on the same side as the sharp edge of the cutting shoe.
5. Slide the cutting shoe together with the sample ring over the fixing pins of the ring holder and turn the cutting shoe in such a way that it cannot slide off.
6. Allow the ring holder together with the fitted handle to drop to the bottom of the sample hole. Make a reference mark on the extension rod so that it is simple to determine the depth to which the ring holder should be pushed into the soil.

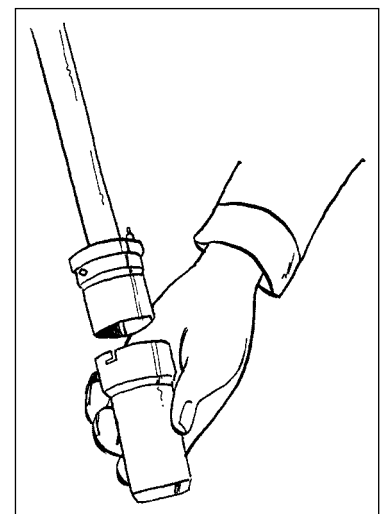

7. Push the ring holder in a straight line into the soil, so that the entire sample ring is filled. However, do not push too far, to avoid compressing the soil in the sample ring. If necessary, the ring holder can be driven into the soil using an impact absorbing hammer.



**If impact force is required, always use the impact absorbing hammer. It is safer and prevents damage to the equipment. Never use a non-impact absorbing (metal) hammer. This can damage the auger and there is a chance of injury resulting from the recoil of the hammer.**

8. Turn the ring holder a quarter turn (90°) to separate the sample material in the sample ring from the soil.  
9. Lift the ring holder while turning it slowly.  
10. Rotate the cutting shoe (10) such that it can be slid off in a straight line.  
11. Remove the sample ring from the equipment and use a saw to remove the excess soil. (See figure page 7)



**Ensure that the sample does not become damaged when the excess material is removed as a result of it being smeared out or by removing too much material.**

12. Fit the protective covers over the sample rings, record the details and store the rings in the supplied case.  
13. After taking a sample, thoroughly clean the sample ring holder using a wire brush, this prevents the sample rings becoming stuck.  
14. Before storing the equipment, thoroughly clean and dry the augers, the sample ring holder and the other parts.

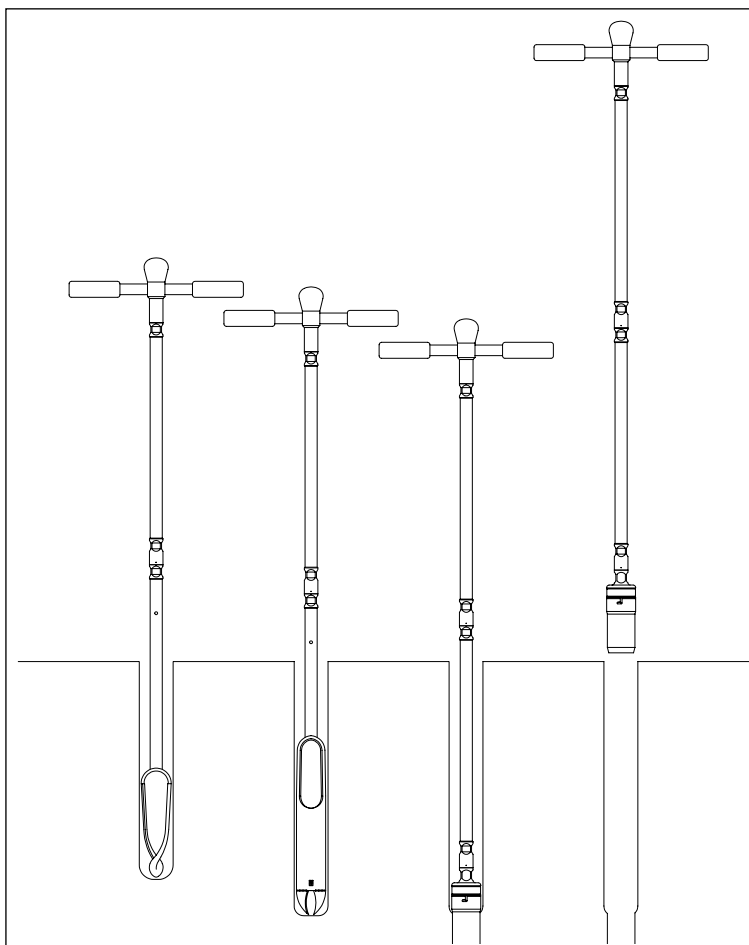
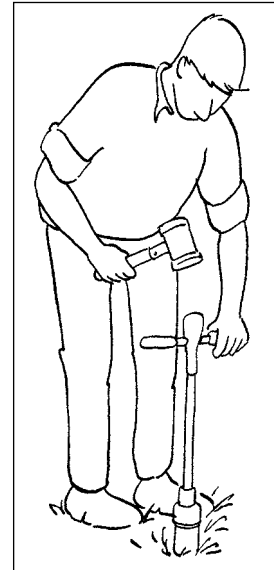



## 5.3 Augers



**If the supplied augers are unsuitable; use another auger, such as a percussion gouge.**

1. Hold the Edelman auger by its handle and rest it on the ground. Using some pressure, rotate the auger clockwise into the soil. After approximately  $2\frac{1}{4}$  full turns (of  $360^\circ$ ) the auger will have bored itself 10 cm into the ground. The auger will then be filled up to the bracket with slightly disturbed soil material. Dependent on the type of soil it requires more or less turns to fill the auger.

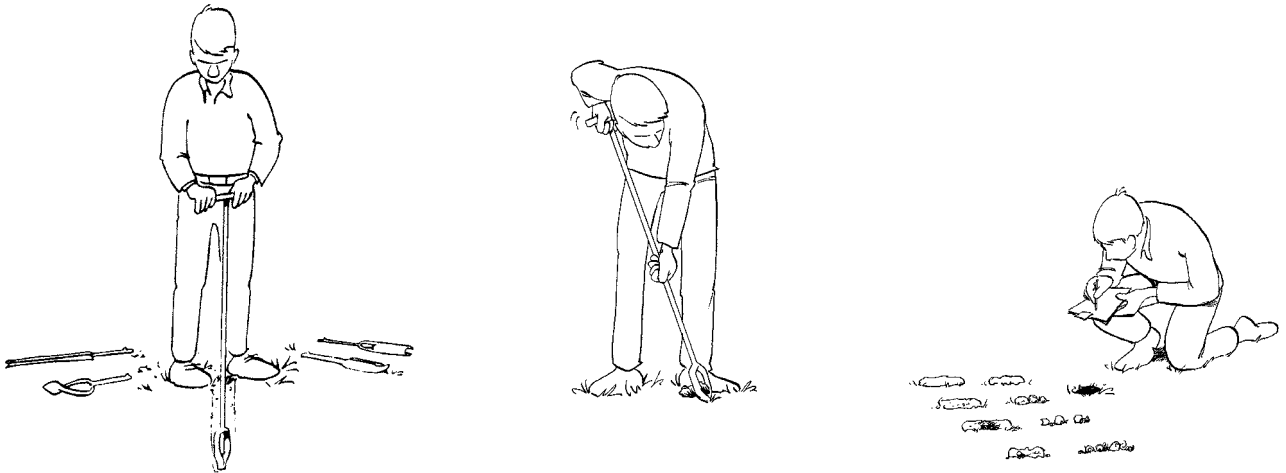

Rotate the auger until it is completely in the ground and then lift it out of the hole while rotating it slowly. To remove cohesive material, place the auger at an angle with its point on ground. While pushing firmly, rotate the auger into the ground for half a turn ( $180^\circ$ ). The material will come loose from the point and can be removed from the auger by hand or by ticking it lightly on the ground. Material that has little cohesion can be removed immediately. Continue boring until the desired depth has been reached.

Prevent:

- An overloaded auger. This will cause the surplus material to be smeared against the sides of the auger hole, causing it to get narrower and therefore making it harder to continue boring. Moreover, it is more difficult to remove the material from the auger. When using an auger under the groundwater level, an overloaded auger can be subject to much suction, which makes it very difficult to lift and can result in the loss of the sample.
  - Loss of sample. Rotate the full auger slowly while it is being removed, so do not just pull it straight up.
2. Disconnect the top part from the Edelman auger (21) and fit it to the Riverside auger (22).
  3. Rotate the Riverside auger (22) into the soil while exerting some pressure. The Riverside auger makes an auger hole with smooth sides. (See figure page 8) Remove the full auger. Tick the auger on the ground lightly and the material will come loose.



**The depth of the auger can be read from several marks. The small pins on the bottom parts indicate 50 cm from the bottom of the auger. The top part has a large mark that indicates a depth of 1m.**

## 5.4 Hammering head for sample rings

1. Push the sample ring into the hammering head (16) so that the sharp edge of the sample ring protrudes. The retaining ring (17) in the hammering head (16) holds the sample ring in position.
2. Push the guide cylinder (20) into the ground.
3. Hammer the hammering head and sample ring into the ground using the impact absorbing hammer until the machined part of the hammering head rod is at the same height as the top of the guide cylinder (20). The vent hole prevents pressure building up.

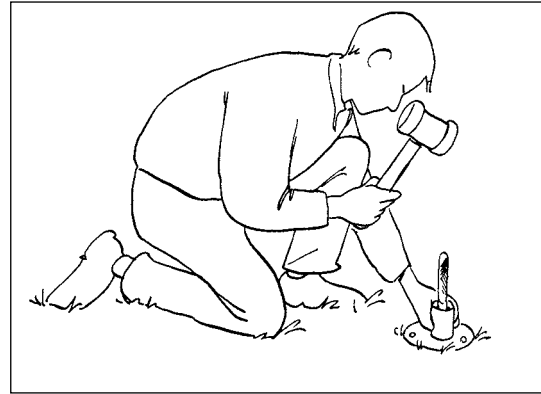

**If impact force is required, always use the impact absorbing hammer. It is safer and prevents damage to the equipment. Never use a non-impact absorbing (metal) hammer. This can damage the auger and there is a chance of injury resulting from the recoil of the hammer.**

4. Remove the guide cylinder after the hole has been made. Use the spatula to dig out the hammering head to far below the sample ring.
5. Remove the sample ring and use a saw to remove the excess soil.



**Ensure that the sample does not become damaged when the excess material is removed as a result of it being smeared out or by removing too much material.**

6. Fit the protective covers over the sample rings, record the details and store the rings in the supplied case.
7. After taking each sample, thoroughly clean the sample ring holder using a wire brush, so that the sample rings can be fitted and removed easily and to prevent contamination of the sample.
8. Before storing the equipment, thoroughly clean and dry the augers, the sample ring holder and the other parts.

## 6. Applications

Soil sample rings are used to take undisturbed soil samples. These samples are used, for example, to determine:

- The moisture content at various moisture tensions (from which a pF-curve can be made).
- The water permeability.
- The air permeability.
- The weight by volume.
- The density.
- The soil-water-air ratio at field capacity.
- The pore distribution.
- The oxygen diffusion.

Application ranges of the various soil sample kits:

### Versions of soil sample kits

07.53.SA  
07.53.SC  
07.53.SE  
07.60.SC  
07.84.SC

### Suitable for

soft soils up to 2 m  
all soils up to 2 m, also below groundwater level  
all harder soils up to 2 m, also below groundwater level  
all soils up to 2 m, also below groundwater level  
all soils up to 2 m, also below groundwater level

## 7. Problems and solutions

### The sample ring is not filled.

- ❑ The soil sample ring was not forced deeply enough into the soil. Make a reference mark, for instance using an elastic band or chalk that can be used to check the sample depth.
- ❑ The soil sample ring is forced too far into the soil, causing the sample in the sample ring to break up and part of the sample to remain in the soil. Make a reference mark, for instance using an elastic band or chalk that can be used to check the sample depth.

### The soil sample ring falls from the open ring holder.

- ❑ Thoroughly clean the lever (4), cylinder halves (2), sleeve (5) and sample ring. Refit the sample ring and slide the sleeve (5) tightly under the lever (4).

### The closed ring holder is being used. Due to the required level of insertion and extraction forces, damage is feared.

- ❑ The reinforced ring holder (as included in set 07.53.SE), see drawing at the right, is capable of handling greater insertion and extraction forces, because, for among other things, the cutting shoe is fitted using hexagon head bolts. This ring holder is suitable for sample rings Ø 53 mm. The article number is 07.03.03.53.C.

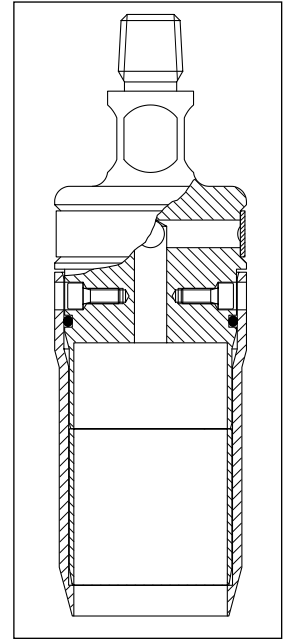

## 8. Maintenance

- ❑ If the retaining ring of the closed ring holder or hammering head is damaged, it must be replaced. There must be no torsional stress in the fitted retaining ring.
- ❑ Replace the vent of the closed ring holder or hammering head if it is damaged. Ensure that there is no torsional stress in the fitted vent.
- ❑ Use a brush to keep the equipment clean during use. It makes sense to thoroughly rinse the equipment with water after use and to dry it thoroughly before storing it.

Nothing in this publication may be reproduced and/or made public by means of print, photocopy, microfilm or any other means without previous written permission from Eijkelkamp Agrisearch Equipment.

Technical data can be amended without prior notification.

Eijkelkamp Agrisearch Equipment is not responsible for (personal damage due to (improper) use of the product.

Eijkelkamp Agrisearch Equipment is interested in your reactions and remarks about its products and operating instructions.

## Appendix: Rust on augers and gouges

These augers and gouges are made of high tensile-strength forgeable iron-manganese steel. Both iron and manganese are non-toxic metals, abundant in the earth's crust on which we live. Natural concentrations are very high. During storage and transport some rust may develop on the bare metal surface. During first use this rust will scour off quickly. You may also scour with some wet sand prior to first use. The auger or gouge is then ready for sampling of soil on all metals like zinc, cadmium, chromium, copper and even iron and manganese!

### **Question 1: How do I clean and maintain my augers / gouges?**

In practice augers keep themselves clean (and sharp) by the high friction of soil particles rubbing the augers surface. Augers or gouges used in acid, saline or alkaline soil are prone to oxidation and should be rinsed with pH neutral water after use. After a drilling in an oil-polluted borehole you may clean the auger with a brush in a bucket with water with neutral baby-shampoo added. Spraying our detergent 20.05.29 is very effective too and will also mobilize trace-metals, even the zinc plating from the extension rods! Use this detergent with care or limit the use to stainless steel or plastic tools only. Isopropylalcohol on a tissue is fine for rapid on-site cleaning. Acetone is more effective and will even remove tars from metals. Dismantle coupling sleeves and other loose parts prior to cleaning to allow rapid and complete drying after the final water rinse. Store in a well ventilated area free from dust and, for plastic materials, smells.

### **Question 2: Why did we not prevent the development of natural rust?**

A paint will blister off quickly and will pollute samples with a variety of organic pollutants during a prolonged period, necessitating a difficult and cumbersome cleaning procedure prior to first use.

A zinc plating is very soft. The zinc will be scratched off in a few dozens of drillings resulting in measurable quantities of zinc in your soil samples and influencing your measurements during a prolonged period. After a few days or weeks the zinc has completely disappeared and is not effective anymore.

A wax or grease is easy to put on, but fairly hard to remove and, again, risky. Greases, oils and waxes will influence a gas chromatogram (GC) made from soil samples taken with such an auger or gouge. In addition the layer is sticky and it is unavoidable that it will spread all over in carrying bag or case, extension rods, gloves and consequently soil samples. This should be avoided at all times.

### **Question 3: The extension rods and upper part are zinc plated. Does this zinc plating contaminate the soil sample?**

No, since there is no intense scouring contact between soil sample and the rods there is no influence.

### **Question 4: Do stainless steel soil samplers (coring tubes and rings) contaminate soil samples?**

Stainless steel is an alloy of high percentages of mainly chrome, iron and nickel. Alloys have characteristics that are different from the characteristics of a simple "mix" of these metals! Stainless steel is so chemically stable that no loose oxides are formed. It is also hard; scouring with soil will not lead to detectable levels of iron, chromium or nickel concentrations in soil.

### **Question 5: Does the chromium plated gouge Model P (04.03) contaminate a soil sample?**

This gouge is plated with a pure thick layer of nice shining chromium. Chromium is an extremely hard metal and will only and partly be rubbed off in years of use! Although there is very little chance that these quantities will contaminate a sample with Chromium we would not recommend this gouge as first choice for soil analysis on chromium.